

USER MANUAL



Thank you for choosing Better Bathrooms.
Please read this manual before installing your product
and keep for future reference

better
bathrooms

Product name –Thermostatic Bar Shower Valve
**Product code - BeBa_26798/BeBa_26799/BeBa_26800/
BeBa_26801/BeBa_26802/BeBa_26803**

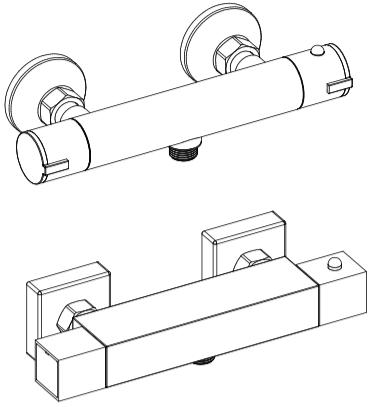

Congratulations on your purchase

And welcome to our growing gang of savvy shoppers

We're on a mission to bring you extraordinary bathroom products, for less. From modern to traditional style ceramics, plus the gorgeous fixtures, fittings and furniture to match. So, you can fall in love with your space every single day.

As one of the UK's largest independent bathroom stores, we've received countless awards; including the National Business Awards UK, the Digital Entrepreneur Awards and being placed on The Sunday Times Fast Track 100.

We hope your new product exceeds your highest expectations. However, if you experience any problems, please:

- log in to your account and contact our customer services team via your self-serve portal-betterbathrooms.com/CustomerAccount/Login.
- contact us via-betterbathrooms.com/content/contact-us.

Important information

- Please read these instructions thoroughly and retain for future reference
- Water pressures must be balanced. Always ensure to flush the system prior to installation.
Always check walls for pipes and cables before drilling.

Maximum Static Pressure 10 bar
Maximum Working Pressure 5 bar
Minimum Working pressure 0.5 bar
Hot water supply – 55-65c
Cold water supply – 5 -25c
Flow Rates

Bar	0.1	0.2	0.5	1	1.5	2
L/Min	3.9	5.5	9	12.7	16.6	18

Parts / Diagrams

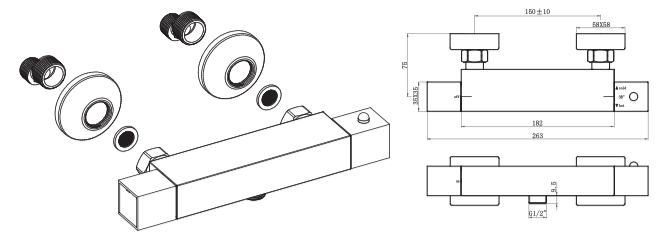
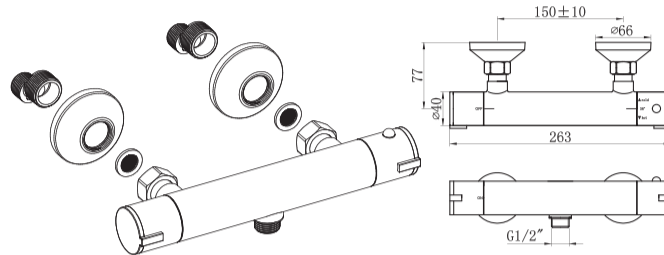

Tools required

- Protective cloth

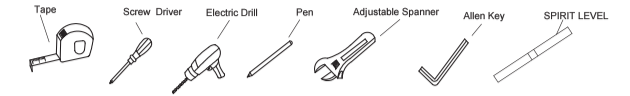

Installation

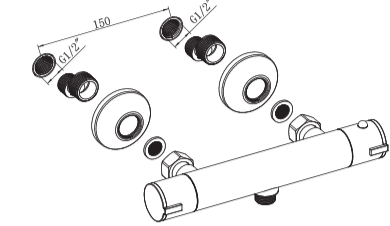

The valve should be installed in accordance with the water bye-laws. For further details refer to the latest copy of Water Bye-laws guide or your local water authority.

1. Fit off-set connectors to the water inlets in the wall using a suitable sealing method, then screw the concealing covers onto the off-set connectors until they come into contact with the wall. Seal with an appropriate sealant.
2. Fix the connector of shower valve to the off-set connectors with spanner. Please use a cotton sheet inside of spanner in case of any scratches. Make sure hot inlet on the left and cold inlet on right, otherwise it will affect the performance.

OPERATION

To open the mixer, turn on/off handle anti-clockwise.
To close the mixer, turn on/off handle clockwise.

To decrease temperature, turn the temperature control handle clockwise.
To increase temperature, turn the temperature control handle anti-clockwise.

- Single-person assembly
- We always recommend using professional tradespeople to install your product

V2_07.12.2021

RECALIBRATE

The temperature control handles on this product are factory set and should require no adjustment.

However, if for any reason the handles and/or the cartridge is removed, it is important the following procedures are followed.

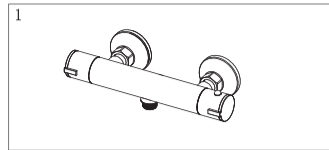

- 1) Quarter-turn the handle on the left anti-clockwise, the water will come out.
- 2) Allow the water temperature to stabilize around 3 minutes and check the temperature by thermometer.
- 3) Proceed if temperature is not 38°C.

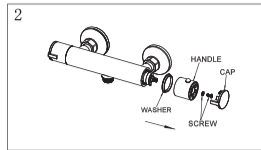

- 1) Take off the cap.
- 2) Untighten the screw.
- 3) Pull handle and washer from mixer.

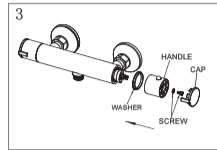

- 1) Turn on the valve.
- 2) Temperature is up when valve stem is turned anti-clockwise, temperature is down when valve stem is turned clockwise.
- 3) When temperature is correctly set, fix the handle back to the valve as show above.
- 4) Tighten the screw, adjust the handle properly, then fix the cap to the handle. Turn the temperature handle to the stop 38°C position to test and to carry out this process.

REPLACE ON/OFF CARTRIDGE

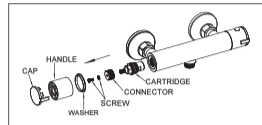

- 1) Take off the cap.
- 2) Untighten the screw.
- 3) Pull handle and washer from mixer.
- 4) Take off connector.
- 5) Turn anti-clockwise to remove cartridge.
- 6) Install replacement cartridge.

TROUBLE SHOOTING

1. Output water temperature does not correspond with recalibration.

Cause: Thermostat has not been adjusted base on the existing home water system

Remedy: Adjust the thermostat , refer to "Temperature Setting" procedure.

Cause: Hot Water temperature too low.

Remedy: Adjust the water heater , increase hot water temperature to 65 °C.

2. Very low flow or no flow

Cause: Supply pressure inadequate

3. Water will not run hot enough when first installed

Cause: Wrong maximum temperature setting

Remedy: Adjust the maximum temperature , refer to "Temperature Setting" procedure.

MAINTENANCE (THERMOSTATIC CARTRIDGE)

* After a period of use, debris or limescale can build up around the filters of the thermostat, which will affect the performance of the product. To resolve this, remove the thermostat from the mixer. Turn off the water supply and turn on the mixer, to drain any water inside. Take off the cap. Remove the screw. Pull the handle from the mixer. Remove the thermostat stop ring (Plastic block) – Take note of its alignment for replacing. Using a spanner remove the retaining nut. Wash the cartridge under running water, a soft brush may also be used to clean away any debris. Replace all parts.

* To avoid damage, please remove all chrome parts before any maintenance takes place.

1) Take off the cap, untighten the screw, to get out handle and washer. The get out plastic block. (See Fig. 1)

2) Untighten the cartridge clamp nut to take out the cartridge. (See Fig. 2)

3) Wash the cartridge with clean running water, dry and lightly grease the seals (only use silicone grease).

4) Replace the cartridge and make sure it back to the primary position.

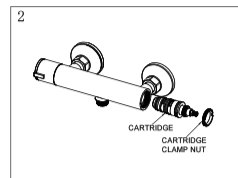
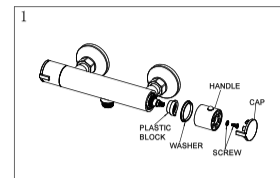

CLEANING

To maintain the surface of your product, wipe with a clean damp cloth and wipe dry.

Do not use abrasive cleaning agents or materials which can strip and scratch the surface; the use of these agents or materials can invalidate your guarantee.

It is recommended to wipe and dry on a regular basis.

For more information

• visit betterbathrooms.com

• email customerservices@buyitdirect.co.uk

• call 03303903062

• write to Trident Business Park, Neptune Way, Huddersfield, HD2 1UA.

**better
bathrooms**

Part of the BuyItDirect Group